

eDocSuit SAP Add-on



Step into a new era of e-compliance with eDocSuit, where modern SAP experience meets seamless control, global readiness, and operational excellence.

Get Started

A native e-compliance experience within SAP

Manage e-invoicing and digital compliance directly inside SAP with a modern, intuitive, and business-friendly experience.

More than an SAP add-on, eDocSuit transforms compliance into a centralized financial operations cockpit.

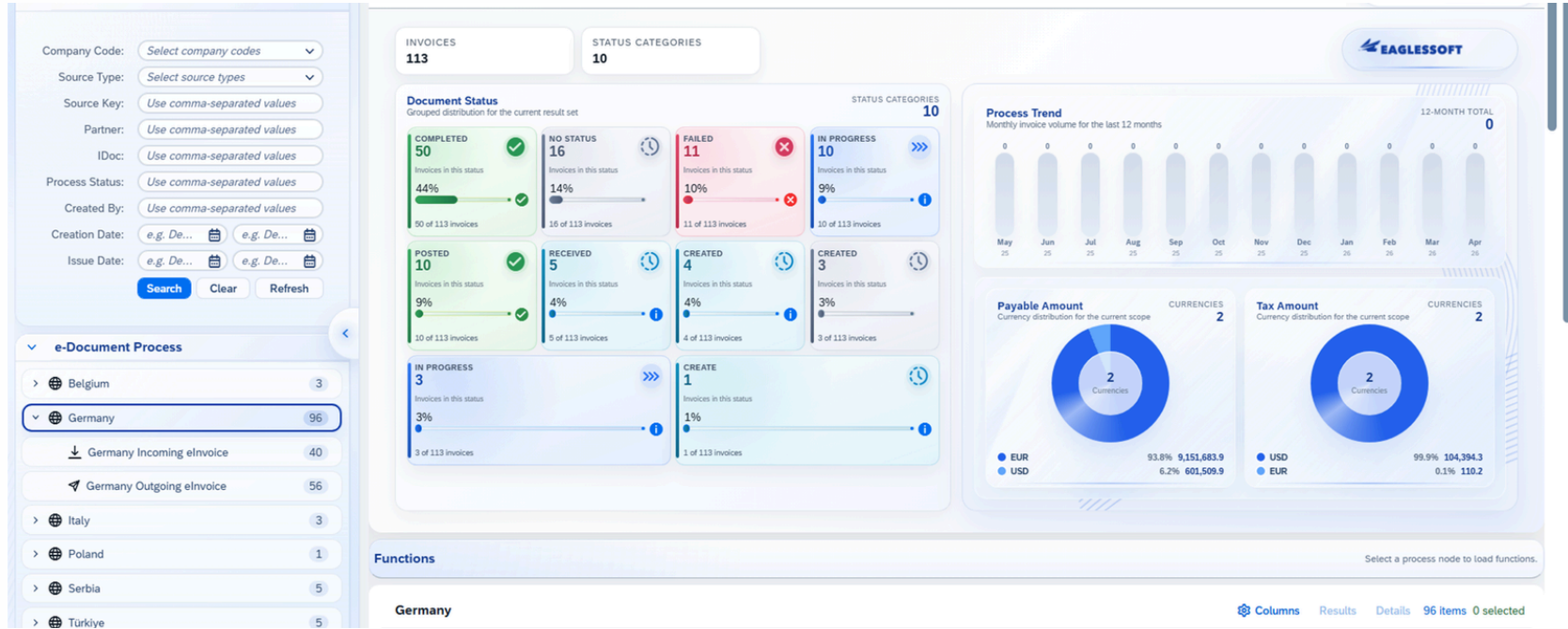



Seamless e-Compliance

- e-Invoice
- e-Delivery
- SAF-T
- e-Ledger

Why SAP Users Need a Better E-Compliance Experience

Growing obligations, growing complexity

- E-invoice, e-dispatch, SAF-T, and e-ledger mandates are expanding rapidly across countries
- SAP users are expected to manage these obligations without disrupting core business operations
- Traditional SAP GUI screens are not designed for speed, visibility, or user comfort
- Companies need a smarter way to manage compliance without leaving SAP

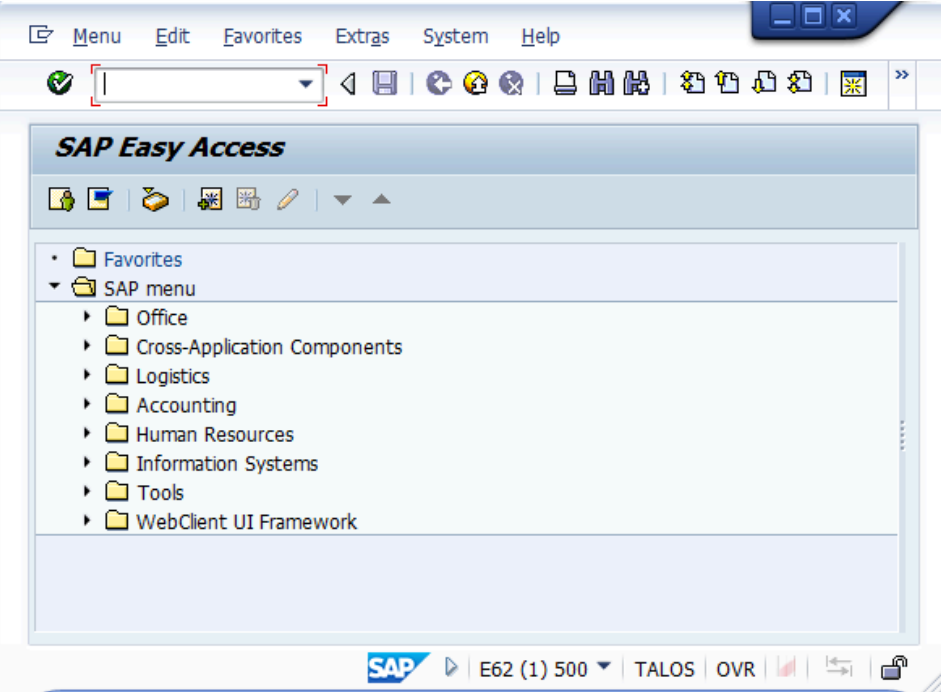

eDocSuit SAP Addon

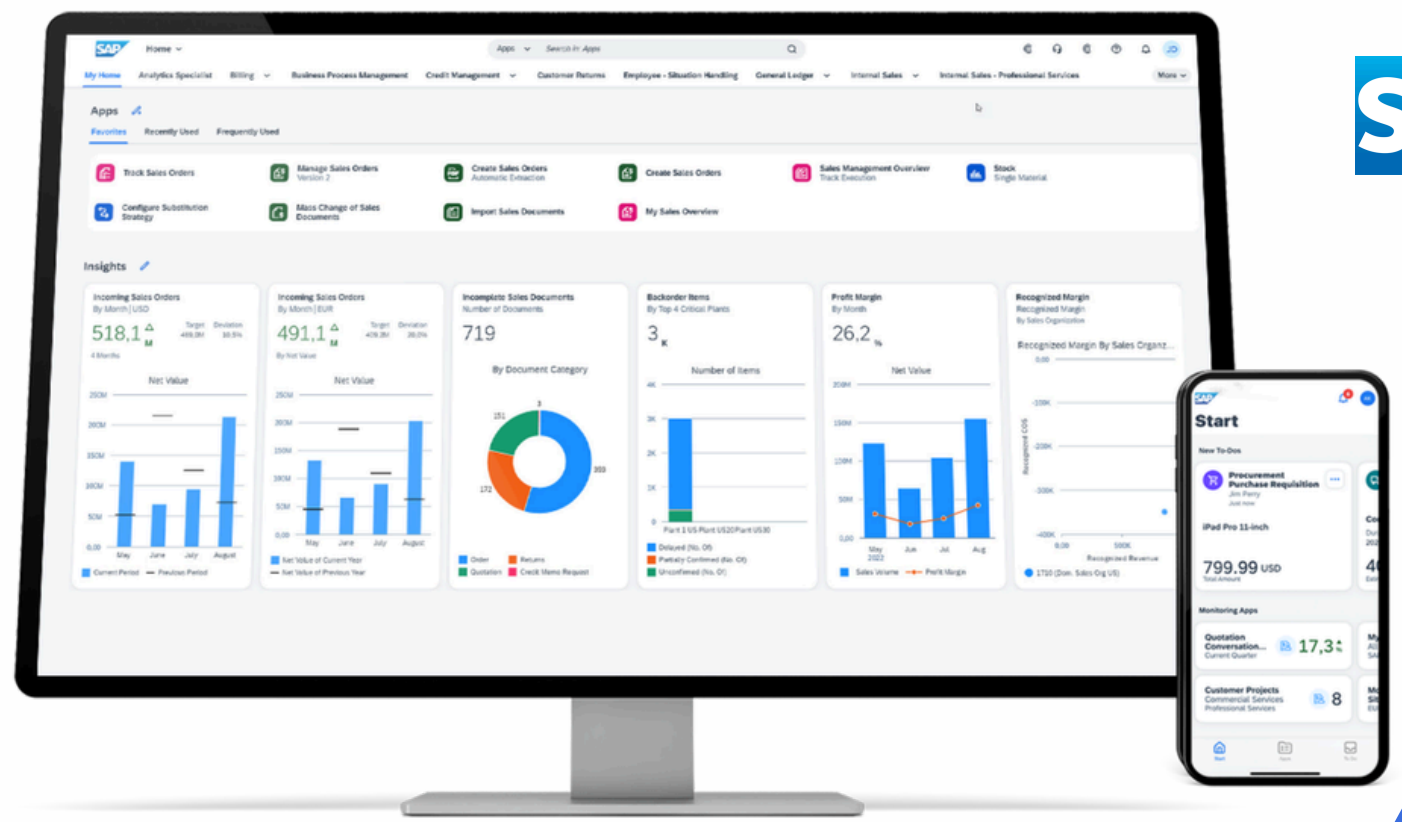

eDocSuit SAP Addon



What If You Could Manage Everything Without Leaving SAP?

eDocSuit enables SAP users to manage all key e-compliance processes from a single centralized cockpit.

From deliveries and invoices to SAF-T and e-ledger, every process is accessible through a modern interface built for business users, not just technical teams.



One cockpit. One experience. Full control.

Modern SAP Experience with Fiori and CDS Views

- Modern Fiori-based user interface
- Fast, intuitive, and visually rich cockpit experience
- CDS Views for powerful and meaningful data presentation
- Easier navigation, faster decisions, better user adoption

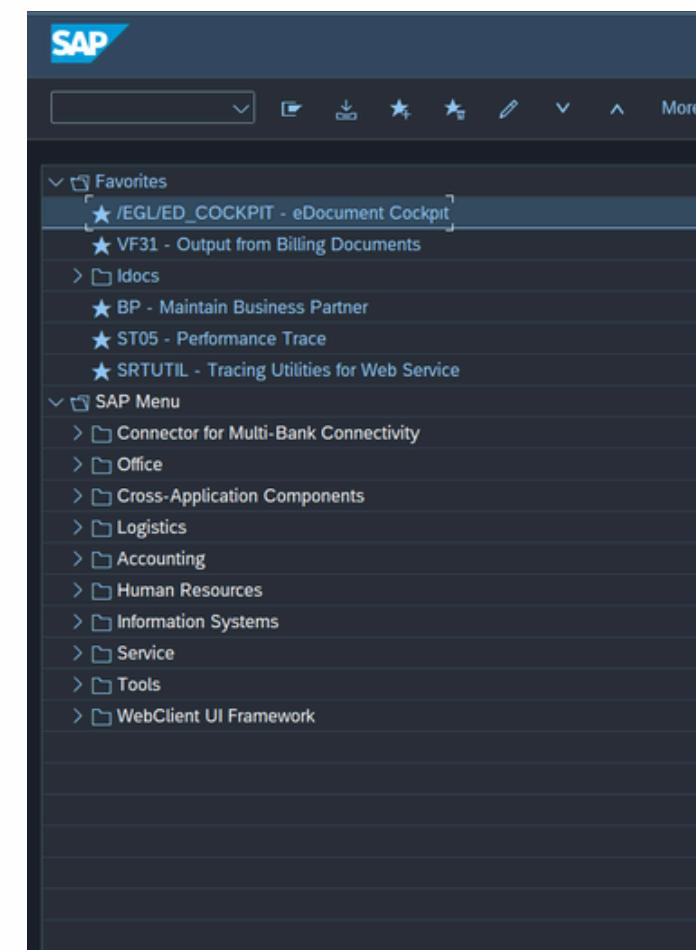

Leave old SAP GUI limitations behind

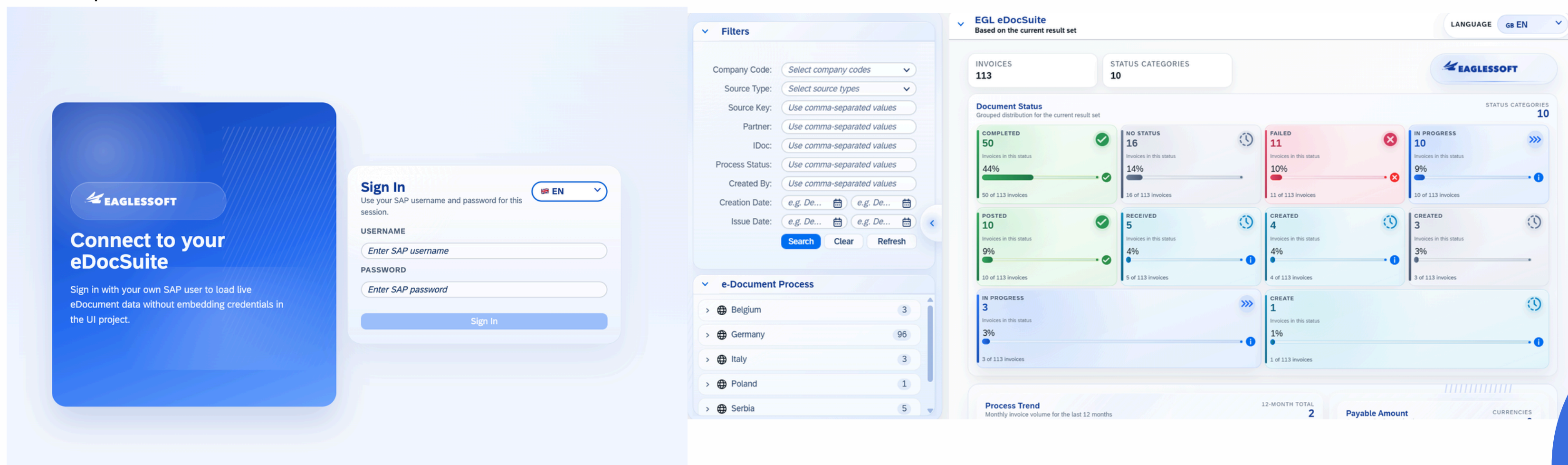

A screenshot of the EGL eDocSuite Fiori cockpit. The interface is clean and modern, featuring a sign-in panel on the left, a filters panel, and a main dashboard with various data cards and charts.

Sign In Panel:

- Language: EN
- Username: Enter SAP username
- Password: Enter SAP password
- Sign In button

Filters Panel:

- Company Code: Select company codes
- Source Type: Select source types
- Source Key: Use comma-separated values
- Partner: Use comma-separated values
- IDoc: Use comma-separated values
- Process Status: Use comma-separated values
- Created By: Use comma-separated values
- Creation Date: e.g. De... e.g. De...
- Issue Date: e.g. De... e.g. De...
- Buttons: Search, Clear, Refresh

e-Document Process Panel:

- Belgium: 3
- Germany: 96
- Italy: 3
- Poland: 1
- Serbia: 5

EGL eDocSuite Dashboard:

- INVOICES: 113
- STATUS CATEGORIES: 10
- Document Status: Grouped distribution for the current result set
- COMPLETED: 50 (44%)
- NO STATUS: 16 (14%)
- FAILED: 11 (10%)
- IN PROGRESS: 10 (9%)
- POSTED: 10 (9%)
- RECEIVED: 5 (4%)
- CREATED: 4 (4%)
- CREATED: 3 (3%)
- IN PROGRESS: 3 (3%)
- CREATE: 1 (1%)

Process Trend: Monthly invoice volume for the last 12 months. 12-MONTH TOTAL: 2. Payable Amount. CURRENCIES.

Built Around SAP, Without Disrupting SAP

Flexible architecture for real SAP environments

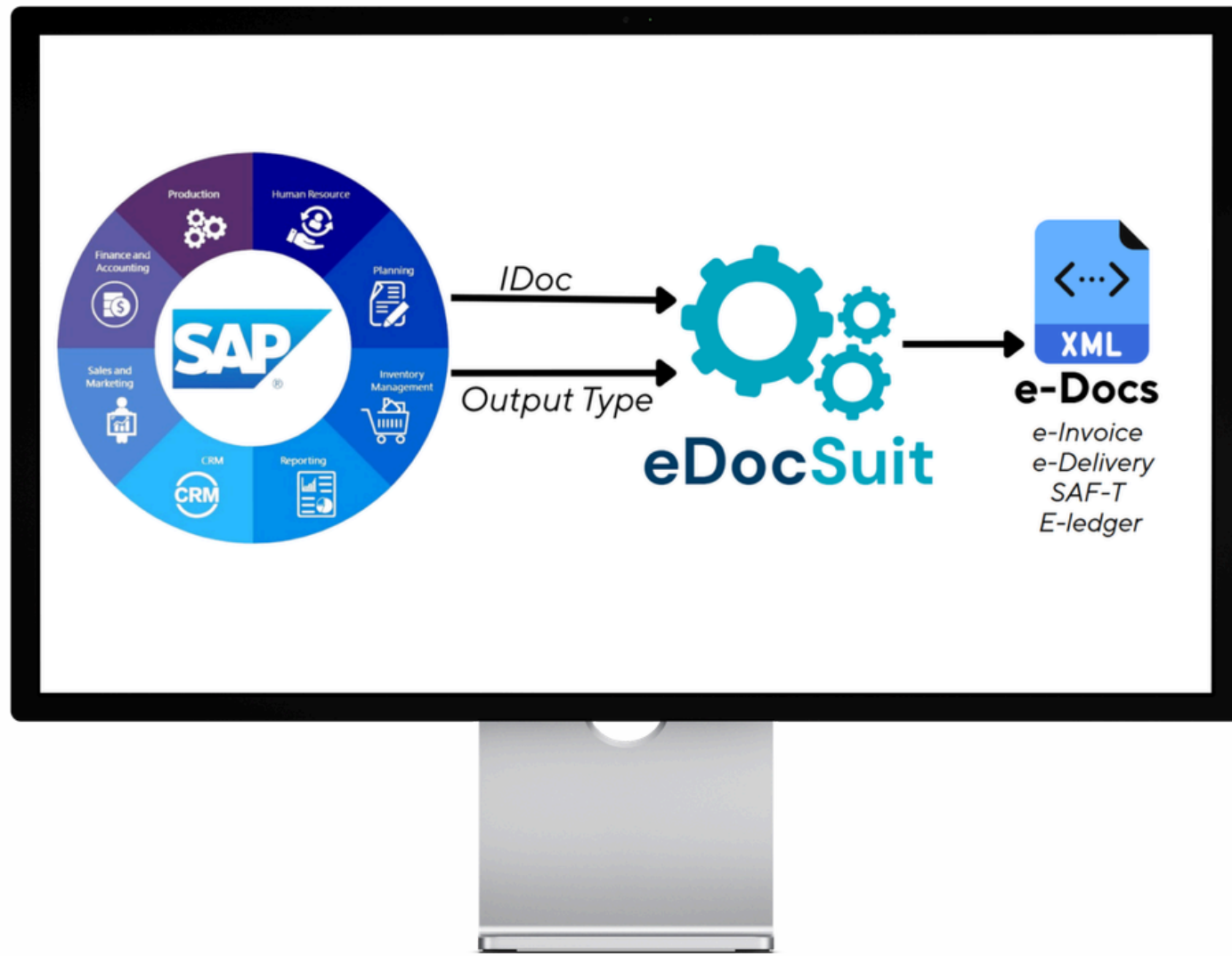

eDocSuit SAP Addon

- Supports SAP IDoc-based data input
- Can also be triggered by output type-based documents
- Fits naturally into SAP business processes
- Preserves SAP integrity while keeping compliance inside SAP

See Every Document, Every Format, in One Place

Full transparency before and after delivery

eDocSuit SAP Addon

With eDocSuit, users can view and manage documents in multiple formats directly from the cockpit:

directly from the cockpit:

- HTML view
- PDF view
- XML view
- IDoc view

Documents can also be downloaded and shared when needed.

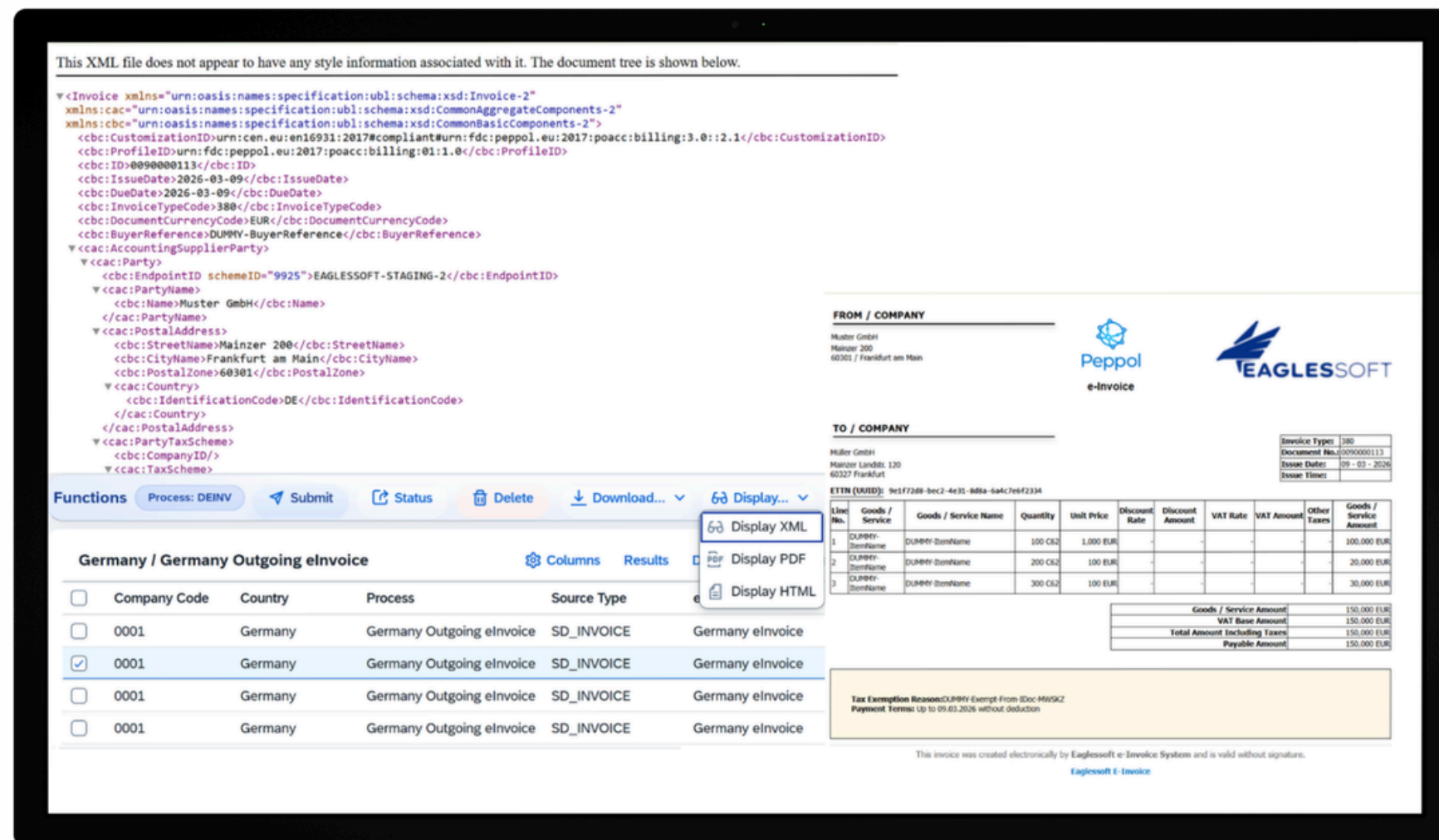

This XML file does not appear to have any style information associated with it. The document tree is shown below.

```
<?xml version='1.0' encoding='UTF-8'>
<Invoice xmlns="urn:oasis:names:specification:ubl:schema:xsd:Invoice-2"
xmlns:cac="urn:oasis:names:specification:ubl:schema:xsd:CommonAggregateComponents-2"
xmlns:cbc="urn:oasis:names:specification:ubl:schema:xsd:CommonBasicComponents-2">
<cbc:CustomizationID>urn:cen.eu:en16931:2017#compliant#urn:fdc.peppol.eu:2017:poacc:billing:3.0:2.1</cbc:CustomizationID>
<cbc:ProfileID>urn:fdc.peppol.eu:2017:poacc:billing:01:1.0</cbc:ProfileID>
<cbc:ID>0090000113</cbc:ID>
<cbc:IssueDate>2026-03-09</cbc:IssueDate>
<cbc:DueDate>2026-03-09</cbc:DueDate>
<cbc:InvoiceTypeCode>380</cbc:InvoiceTypeCode>
<cbc:DocumentCurrencyCode>EUR</cbc:DocumentCurrencyCode>
<cbc:BuyerReference>DUMMY-BuyerReference</cbc:BuyerReference>
<cac:AccountingSupplierParty>
<cac:Party>
<cbc:EndpointID schemeID="9925">EAGLESSOFT-STAGING-2</cbc:EndpointID>
<cbc:PartyName>
<cbc:Name>Muster GmbH</cbc:Name>
</cbc:PartyName>
<cbc:PostalAddress>
<cbc:StreetName>Mainzer 200</cbc:StreetName>
<cbc:CityName>Frankfurt am Main</cbc:CityName>
<cbc:PostalZone>60381</cbc:PostalZone>
</cbc:PostalAddress>
<cbc:Country>
<cbc:IdentificationCode>DE</cbc:IdentificationCode>
</cbc:Country>
</cac:Party>
</cac:AccountingSupplierParty>
</Invoice>
```

FROM / COMPANY

Muster GmbH
Mainzer 200
60381 / Frankfurt am Main

TO / COMPANY

Muster GmbH
Mainzer Landstr. 120
60327 Frankfurt

Invoice Type: 380
Document No.: 0090000113
Issue Date: 09-03-2026
Issue Time:

ETIN (UBL): 9e1f7388-bec2-4e31-8b8a-6ac7e4f2334

Item No.	Goods / Service	Goods / Service Name	Quantity	Unit Price	Discount Rate	Discount Amount	VAT Rate	VAT Amount	Other Taxes	Goods / Service Amount
1	DUMMY-ItemName	DUMMY-ItemName	100	1,000 EUR						100,000 EUR
2	DUMMY-ItemName	DUMMY-ItemName	200	100 EUR						20,000 EUR
3	DUMMY-ItemName	DUMMY-ItemName	300	100 EUR						30,000 EUR
										Goods / Service Amount
										VAT Base Amount
										Total Amount Including Taxes
										Payable Amount

Goods / Service Amount: 150,000 EUR
VAT Base Amount: 150,000 EUR
Total Amount Including Taxes: 150,000 EUR
Payable Amount: 150,000 EUR

Tax Exemption Reason: DUMMY Exempt from IDoc MWSGZ
Payment Terms up to 09.03.2026 without deduction.

This invoice was created electronically by Eaglesoft e-Invoice System and is valid without signatures.
Eaglesoft e-Invoice

Germany / Germany Outgoing invoice

Company Code	Country	Process	Source Type	Document Type
<input type="checkbox"/> 0001	Germany	Germany Outgoing invoice	SD_INVOICE	Germany invoice
<input checked="" type="checkbox"/> 0001	Germany	Germany Outgoing invoice	SD_INVOICE	Germany invoice
<input type="checkbox"/> 0001	Germany	Germany Outgoing invoice	SD_INVOICE	Germany invoice
<input type="checkbox"/> 0001	Germany	Germany Outgoing invoice	SD_INVOICE	Germany invoice

Smarter Outbound Processing

More automation, less manual work

- Send documents manually or automatically via email or other channels
- Add supporting attachments to the main document
- Deliver invoices together with related documents
- Reduce repetitive work through outbound automation

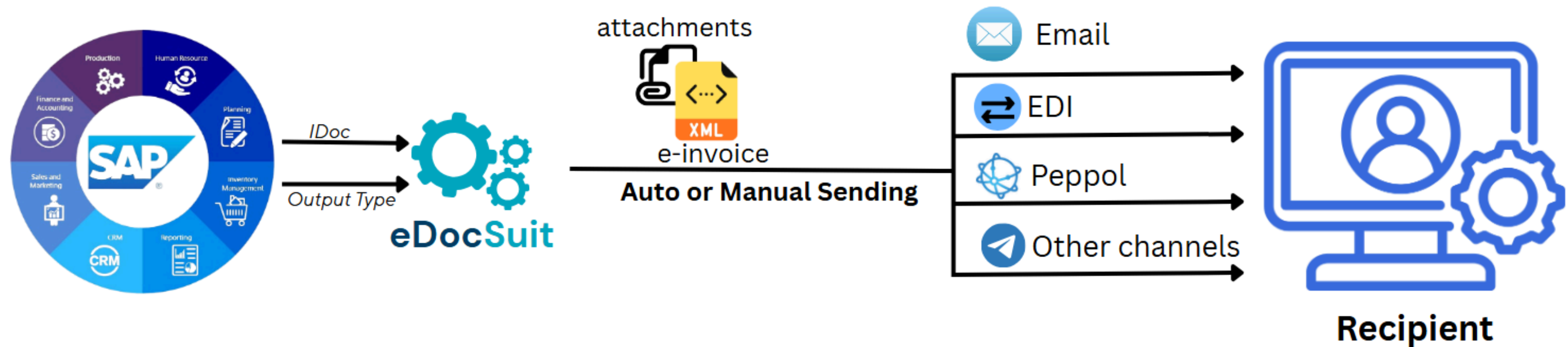

Ready for High-Volume AP Operations

Seamless Integration with Document Systems

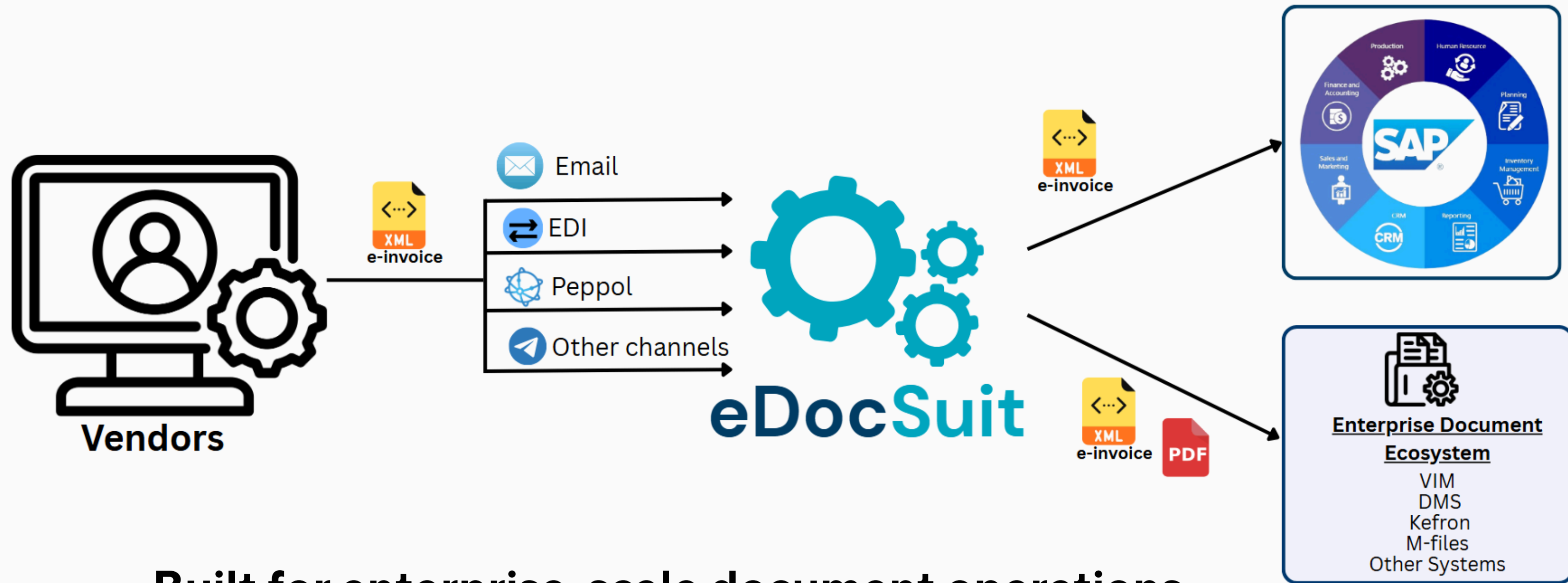

Built for enterprise-scale document operations

Built for Executives, Not Just Operators

A dashboard designed for executive decision-making

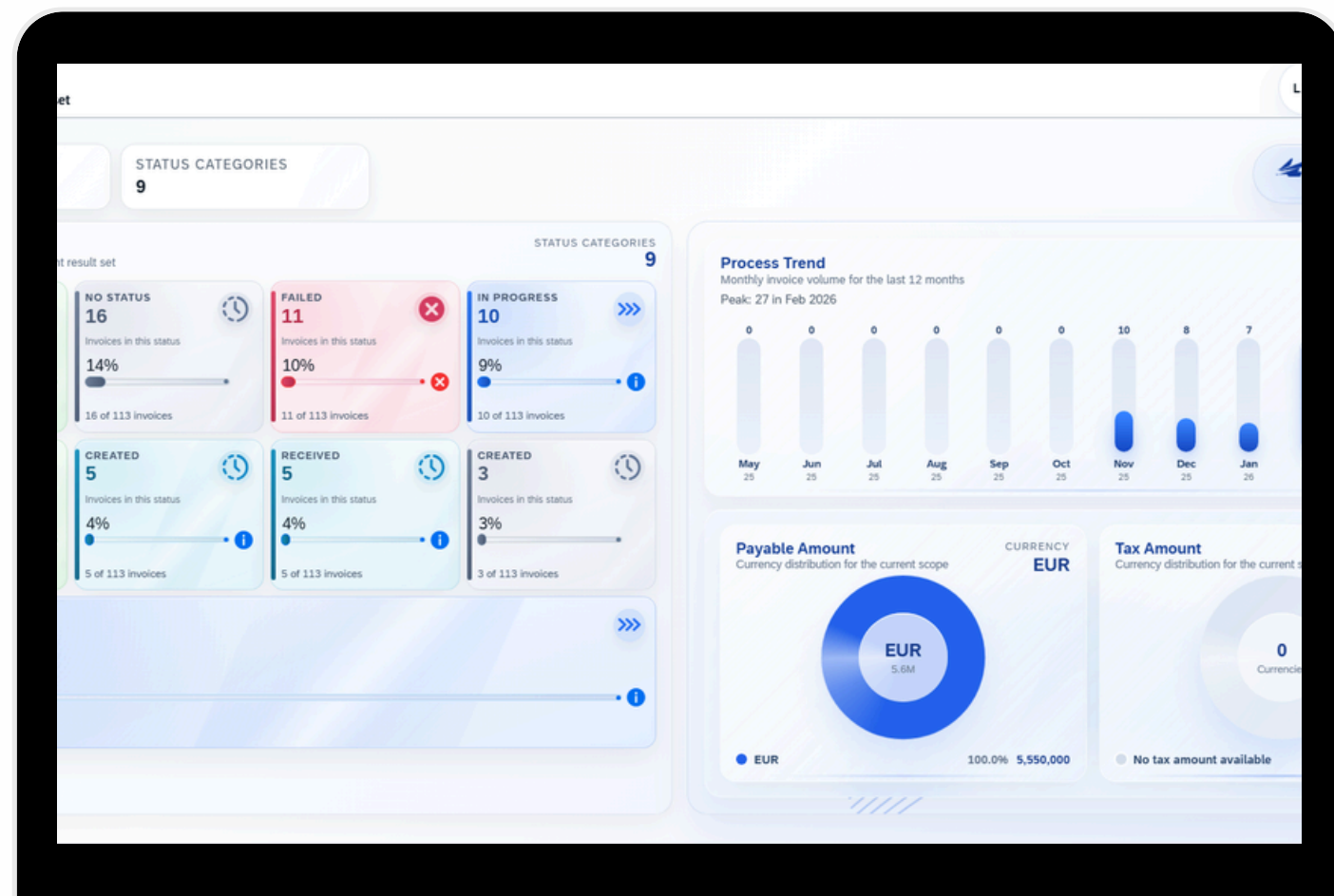

C-level leaders can monitor critical document operations without getting lost in operational detail.

- Clear graphical summaries
- Fast access to problem areas
- High-level monitoring across countries and business units
- Better control over compliance-related financial operations

From operational detail to executive insight in one view.

Advanced Authorization and Document Security

The right people see the right documents



- Role-based access by country, team, and responsibility
- Sensitive documents visible only to authorized users
- Secure governance across global operations

Precision access control across every process and every country.

One Solution for Multi-Country Operations

Manage global compliance from a single SAP environment

- One cockpit for multiple countries
- Country-specific access and visibility
- Central monitoring for HQ and leadership teams
- Local execution with global control

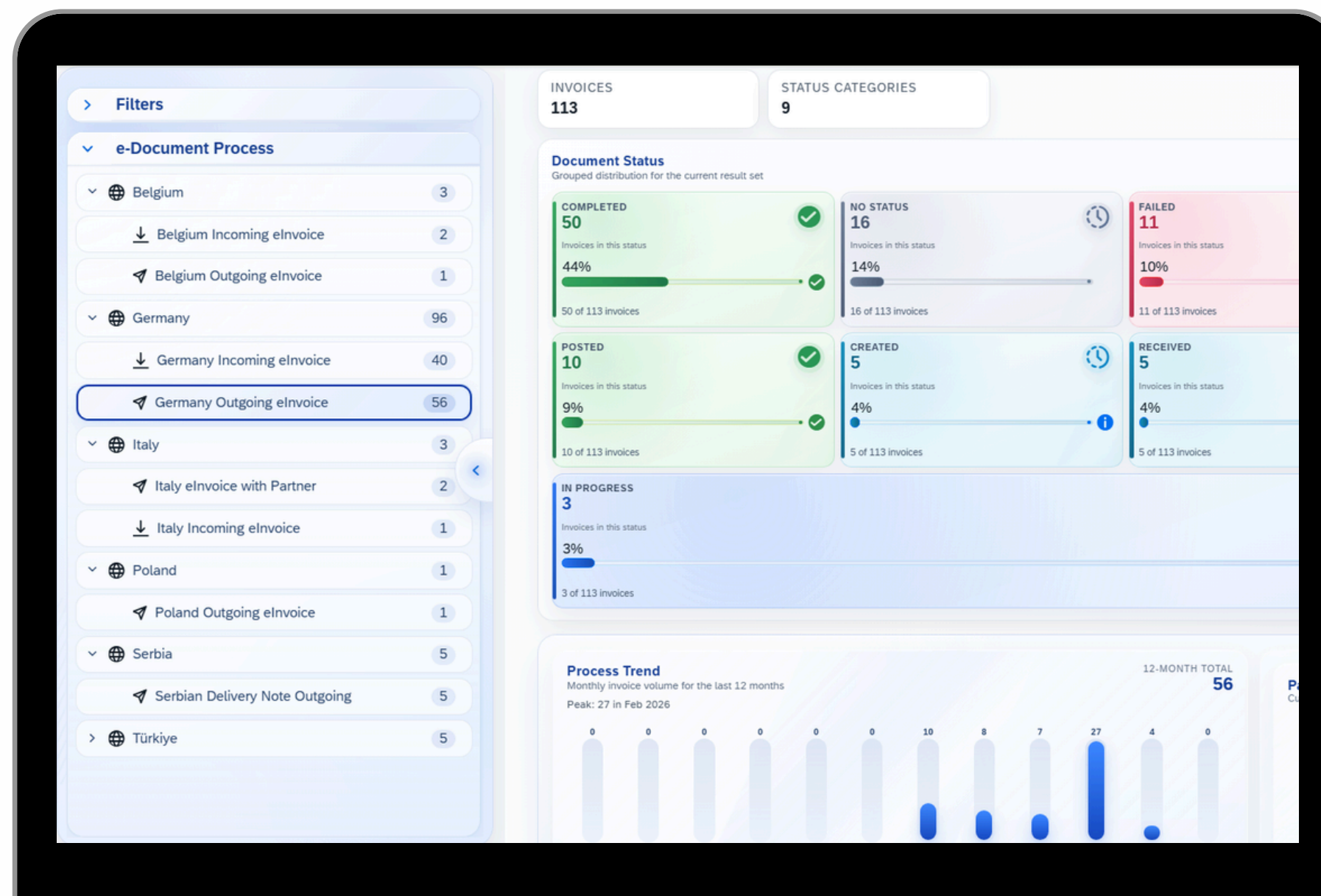

One SAP environment. Multiple countries. Full visibility.

More Than Compliance

A financial operations management tool inside SAP

- Improve operational efficiency
- Reduce manual workload
- Increase visibility and traceability
- Strengthen financial governance

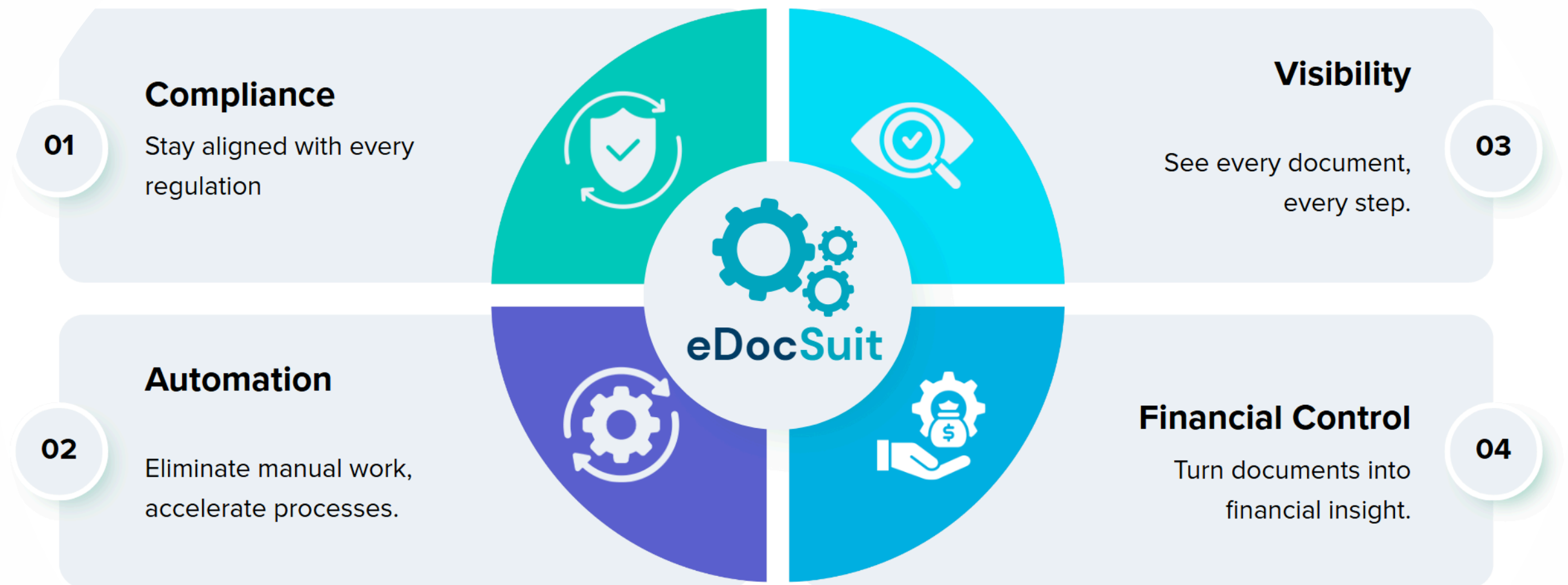

More than compliance. A smarter way to run finance operations in SAP

Why eDocSuit?

The answer to modern SAP e-compliance challenges

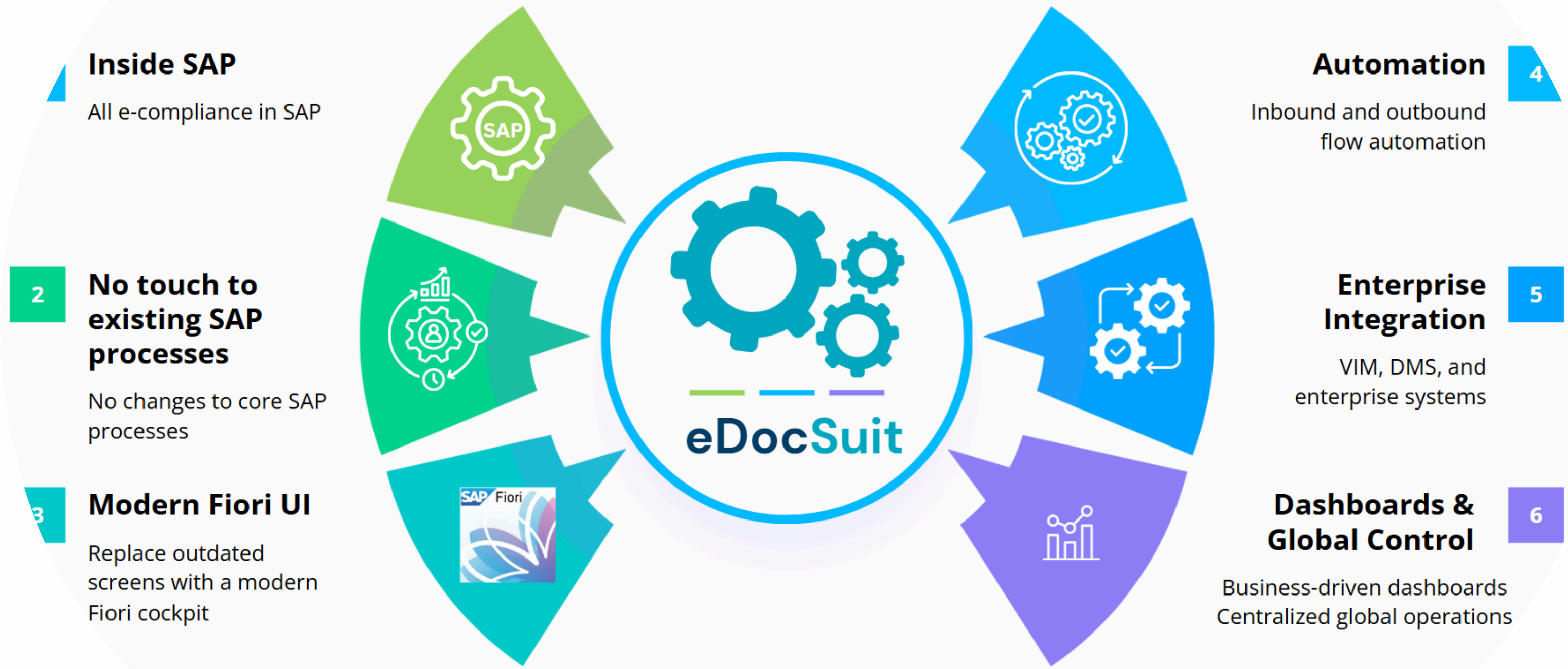

Stay in SAP. Gain control. Simplify compliance.

Contact Us Now!

Get in Touch!

Thank you for
your attention
and collaboration.

Call Now



Contact us by phone, visit our website,
or come to our office.

Phone

+32 456 735 966

Address

Excelsiorlaan 31
1930 Zaventem
Belgium

Website

www.eaglessoft.com